

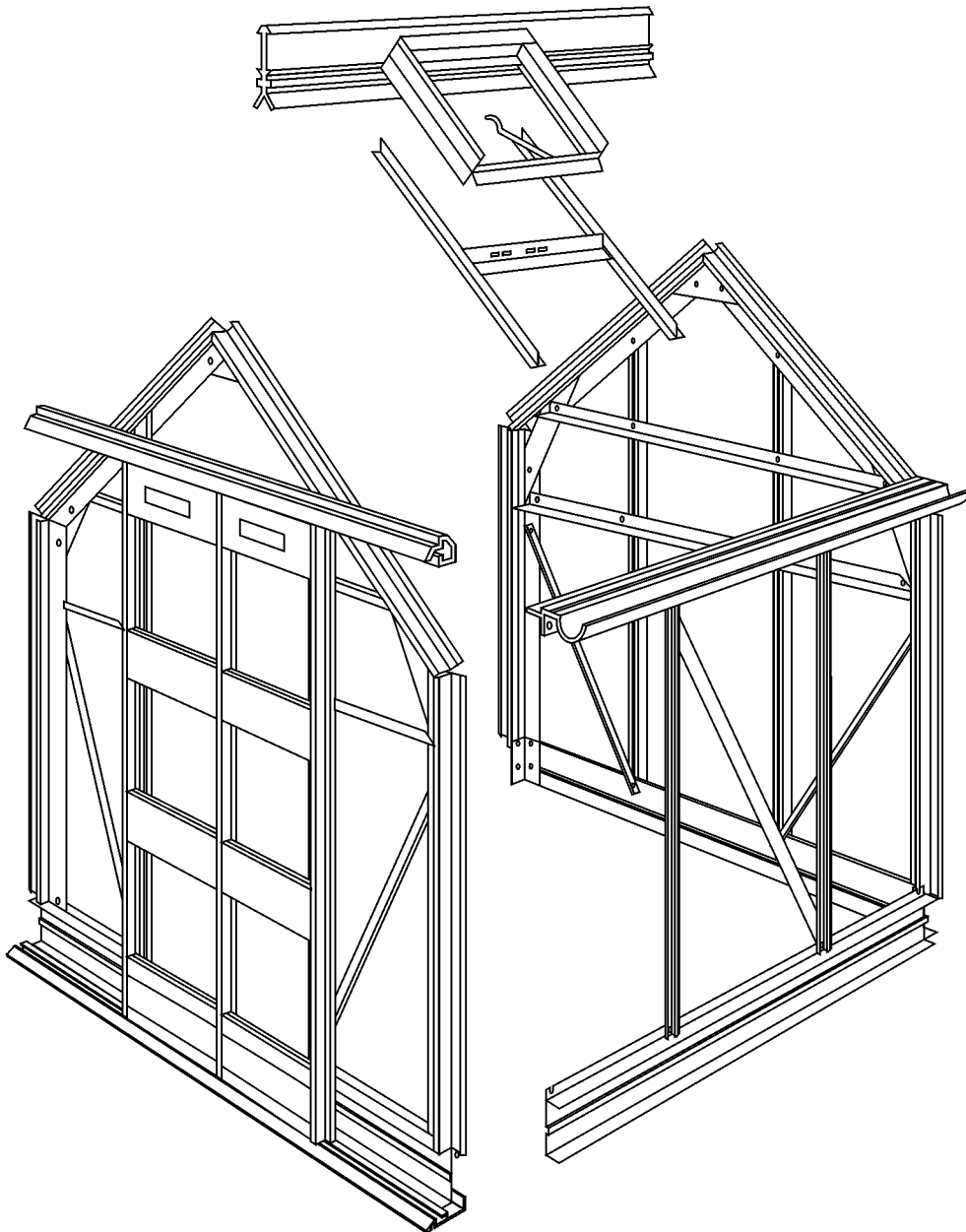

INSTRUCTIONS & ILLUSTRATIONS FOR THE  
**5'3" WIDE DELTA**



**ELITE GREENHOUSES LTD**

BENT SPUR ROAD, KEARSLEY, BOLTON BL4 8PD

TEL: 01204 791488 FAX: 01204 862412

[enquiries@elite-greenhouses.co.uk](mailto:enquiries@elite-greenhouses.co.uk)

[www.elite-greenhouses.co.uk](http://www.elite-greenhouses.co.uk)

**FITTINGS WITHIN THE KIT (NOT TO SCALE)**

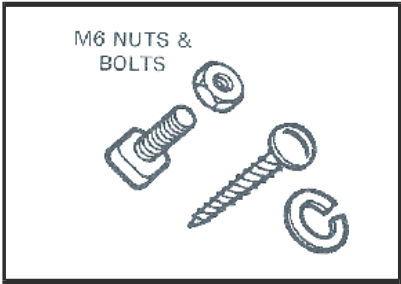

**SELF TAPPING SCREWS  
SPRING WASHERS**

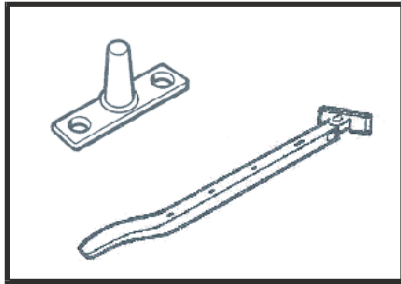

**CASEMENT STAY + PINS**

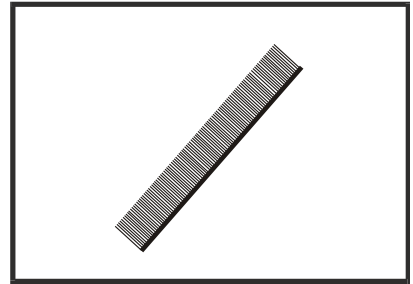

**DRAUGHT EXCLUDER**

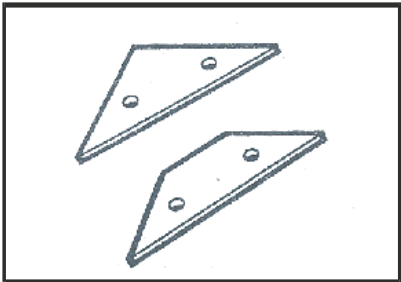

**APEX & EAVE PLATES**

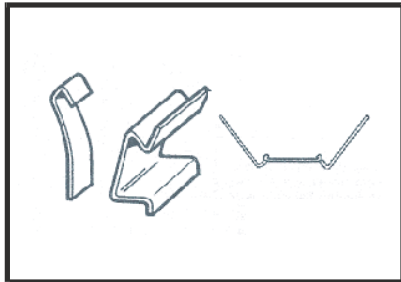

**OVERLAP, SPRING & WIRE CLIPS**

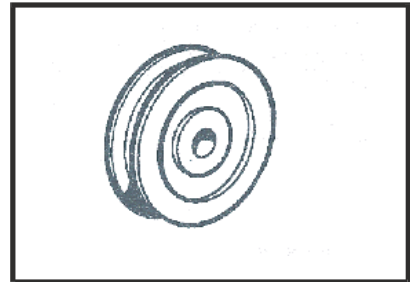

**DOOR WHEEL**

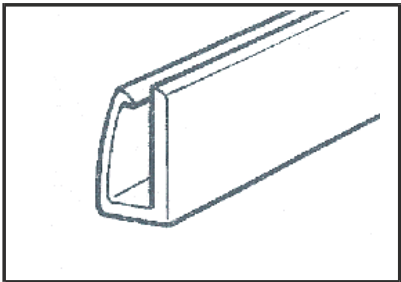

**BLACK DOOR SKID**

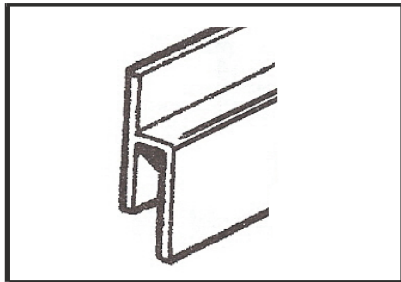

**MUNTIN**

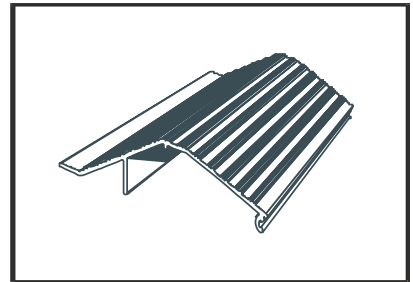

**RAMP**

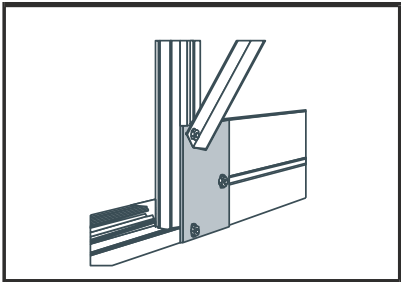

**DOOR END CONNECTING PLATE**

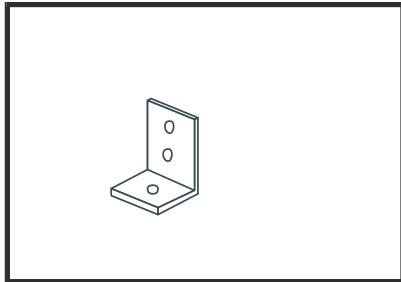

**ANGLE BRACKET**

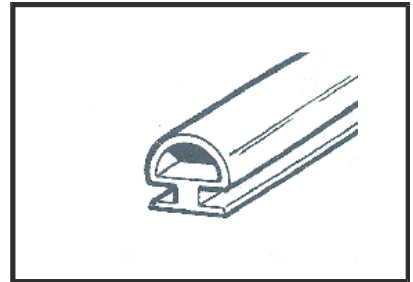

**GLAZING BEADING**

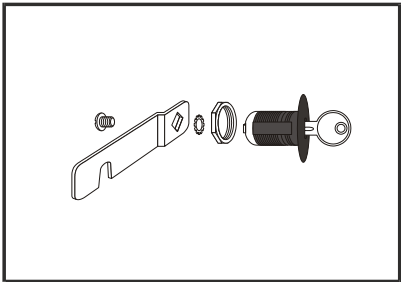

**DOOR LOCK**

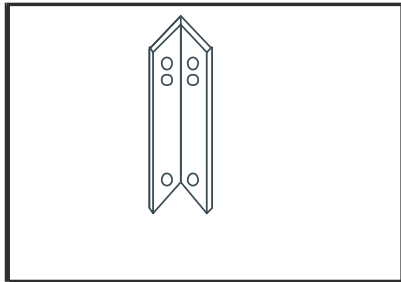

**BASE LEGS (CORNER BRACKETS)**

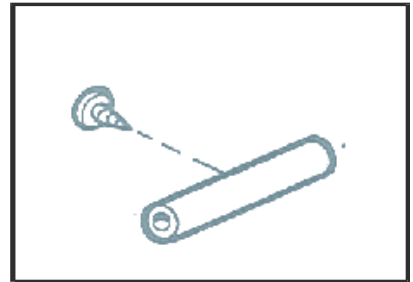

**VENT STOPPER**

**COMPONENT DRAWINGS (NOT TO SCALE)**

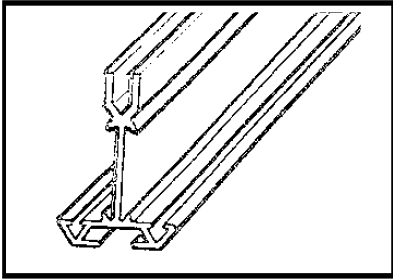

**GLAZING BARS AND DOOR POSTS**

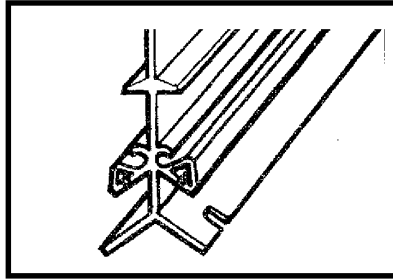

**RIDGE**

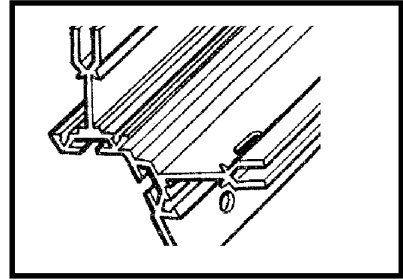

**CORNER BAR**

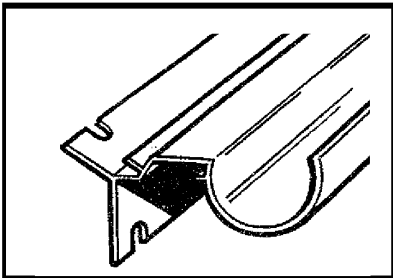

**COMBINED EAVES BAR/GUTTER**

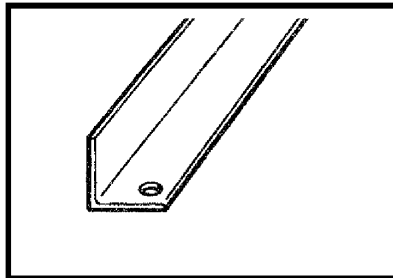

**BRACING ANGLE**

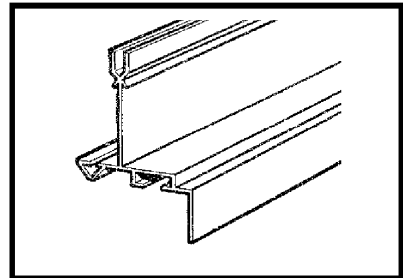

**VENT SIDE RAIL**

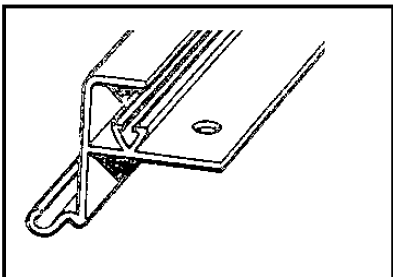

**VENT TOP RAIL**

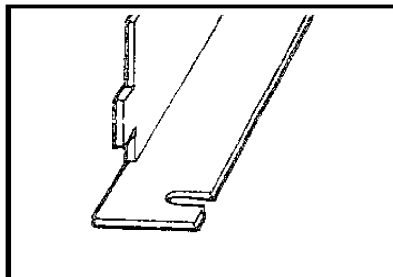

**VENT SLAM BAR**

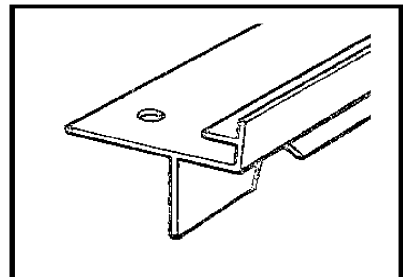

**VENT BOTTOM RAIL**

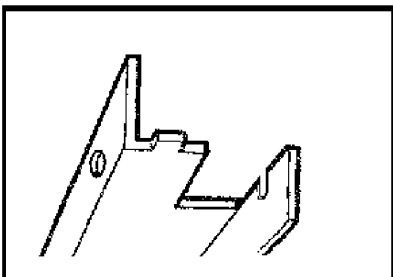

**DOOR TRACK SUPPORT**

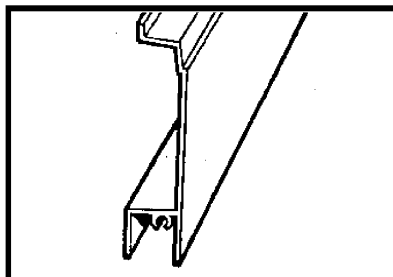

**DOOR IN FIL PANEL**

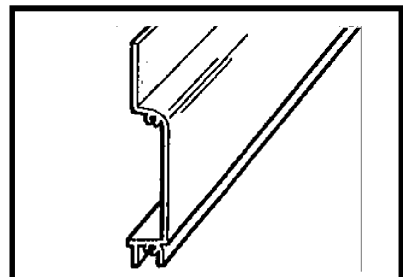

**DOOR TOP/BOTTOM PANEL**

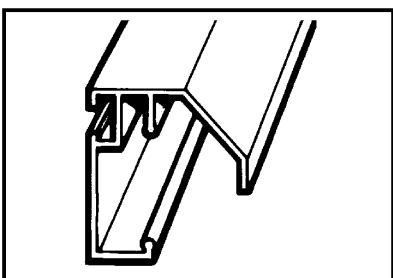

**TOP DOOR TRACK**

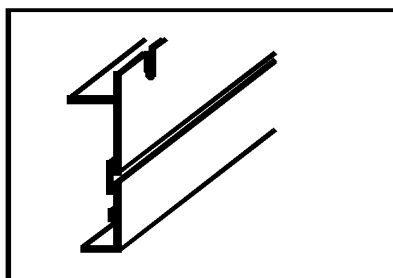

**BUILTIN BASE**

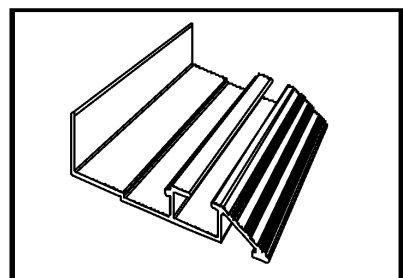

**DOOR END CILL**

## PARTS LIST

			4 x 5	6 x 5	8 x 5	10 x 5
1	Nuts and bolts M6		94	108	122	140
2	Spring clips		182	222	262	302
3	Overlap clips		26	32	38	44
4	Wire clips		16	16	16	20
5	Casement stay		1	1	1	1
6	Stay pins		2	2	2	2
7	Pins, nuts and bolts M4		6	6	6	12
8	Double door catch lock + cam		1	1	1	1
9	Self tapping screw		28	28	28	28
10	Glazing beading (m)		55	64	73	85
11	Door guides		2	2	2	2
12	Door end plates		2	2	2	2
13	Eave plates	Taped together with one casement stay	4	4	4	4
14	Ridge plates		2	2	2	2
15	Door wheels and fittings		4	4	4	4
16	Ridge		1	1	1	1
17	Gutter/eave		2	2	2	2
18	Built in base side		2	2	2	2
19	Side braces		2	2	4	4
20	Door end built in base		2	2	2	2
21	Top door track		1	1	1	1
22	Top door panel	With name plate taped together and marked "door"	2	2	2	2
23	Bottom door panel		2	2	2	2
24	Middle door panel		6	6	6	6
25	Door track support		1	1	1	1
26	Door posts (1 handed, 1 unhand- ed)		2/2	2/2	2/2	2/2
27	Side glazing bar		2	4	6	8
28	Roof glazing bar		2	4	6	8
29	Vent (in packs)		1	1	1	2
30	Door end glazing bars	Taped together and marked "Door end"	2	2	2	2
31	Long door end horizontal bracing angle		2	2	2	2
32	Door end horizontal angle		2	2	2	2
33	Door end diagonal angle		2	2	2	2
34	Door track support flat bar		2	2	2	2
35	Rear end built in base		1	1	1	1
36	Rear end glazing bars	Taped together and marked "Rear end"	2	2	2	2
37	Long rear end horizontal angle		1	1	1	1
38	Rear end horizontal angle		1	1	1	1
39	Rear end diagonal angle		2	2	2	2
40	Corner bars in two packs		8	8	8	8
41	Cantilever brace		2	4	6	8
42	Angle base leg/corner bracket		4	4	4	4
43	Glass	See glazing key at back of booklet				

We reserve the right to make improvements to our range of models.

## HELPFUL HINTS

- Please do take your time and be sure to read all instructions carefully before assembling.
- Do not assemble frame in high winds.
- The greenhouse frame should be anchored to a permanent foundation. This will not only help secure it against powerful winds but will help prevent breakage of the glass caused by the freezing and thawing process of the earth.
- When building your own brick/concrete foundations ensure that they are level and square otherwise your frame will not be correct and the glass will not fit.
- Be sure all four corners of the constructed greenhouse are square before installing glass, and do not install the glass till the greenhouse is on a permanent foundation.
- Do not place your greenhouse in vulnerable locations such as under trees, playing areas, etc.
- Children should not play near glass greenhouses.
- REMEMBER: glass is fragile, handle with care!
- Protective eye glasses should be worn.
- Gloves should be worn.
- If your greenhouse is a painted one there are a few 1/8"/3mm holes in the end of the bars. These are jig holes for painting and have no bearing on construction. **(Key point)**.
- **WHEN CONSTRUCTING A PAINTED MODEL PLEASE TAKE CARE NOT TO DAMAGE THE FINISH BY WORKING ON CONCRETE OR PATIOS. Take great care in opening the polythene packages. Do not run a knife down the side of the packs as this may scratch the paintwork.**
- **N.B. This plan covers the entire Delta range. The only difference between a 4ft long and a 10ft long for example are a few extra pieces of alloy, glass, nuts and bolts etc. The construction of the sub-frame assemblies is the same but for the purposes of this booklet we have used the 6 x 5 model as the benchmark. Therefore only one plan is needed.**
- We reserve the right to alter and improve our products.

# **INSTALLATION INSTRUCTIONS FOR THE 5'3" WIDE MODEL "DELTA RANGE"**

**The contents of this carton are divided into the different frame assemblies that collectively make up the completed greenhouse framework.**

It is recommended that each framework assembly is fully completed before moving onto the next.

The contents are as follows:

1. Two side frames
2. Rear end frame
3. Door end frame
4. Roof vent
5. Doors
6. Bag of fittings containing:
  - a. Nuts and bolts general assembly
  - b. Overlap clips for glass
  - c. Spring clips for glass
  - d. Casement stay
  - e. Casement stay nuts and bolts
  - f. Four eave plates (not in the main bag, but taped up with the casement stay)
  - g. Two ridge plates
  - h. Four door wheels
  - i. Two door guides
  - j. Small self tapping screws
  - k. Double door lock
  - l. Two connecting plates (door end plate)
  - m. Two flat bar small door track supports
7. Roof bars
8. Coil(s) of glazing beading
9. One length of ridge
10. Two black brush draught excluders

**For clear identification of parts and the number required please carefully refer to the earlier pages of component drawings and parts list.**

## SIDE FRAME ASSEMBLY

### STARTING with the side frame

Components required;

4' long = 1 side bar, 1 eave bar, 1 base/cill, 1 angle tie bar

6' long = 2 side bars, 1 eave bar, 1 base/cill, 1 angle tie bar

8' long = 3 side bars, 1 eave bar, 1 base/cill, 2 angle tie bars

10' long = 4 side bars, 1 eave bar, 1 base/cill, 2 angle tie bars

1. Lay out the pieces on the ground as though you were standing inside the house i.e. with the gutter and cill facing downwards and the bolt channel of the glazing bars upwards. (**Key point**). The single bolt slot in the base also faces upwards.
2. **Slide the glazing beading into each side bar taking care not to stretch the material.** Trim off any surplus level with the ends of the glazing bar.
3. Slide a bolt into each end of each glazing bar, and an extra bolt into the top of each side glazing bar. (If you have bought a shelf or louvre to go in your greenhouse and you intend to fit it on a side wall, use the ½" headed bolts provided with the shelf fittings).
4. Fix the combined eaves bar and gutter to the glazing bars pushing the bolts through the holes in the eaves bar and securing with a nut. You do not need to tighten the nuts too much at this stage, but they need to be tight enough to stop the bolts slipping out of the glazing bar.
5. Fix the built in base cill to the glazing bars by pushing the bolt through the hole in the cill unit and tightening as before.
6. Correctly position the built in base cill on the outermost glazing bars by pushing the bolts through the holes in the cill, but do not put the bolts on yet. (8' and 10' models only). The 4' and 6' long models have only 1 side diagonal per side, so the diagonal brace attaches to the bottom of the 1<sup>st</sup> glazing bar (4' long model) and on the 6' model it attaches to the top of one glazing bar to the bottom of the next (as per diagram on page 8).
7. Put nuts on the bottom bolts and lightly tighten.
8. Do the same with the other side frame assembly.
9. Make sure that the glazing bars touch both the cill and the eaves in each case. Tighten all nuts.
10. If you are fitting your greenhouse onto hard standing (flags, concrete etc), then insert bolts into the bolt channel of the built in base (generally 1 every 2'). These will be used to anchor the greenhouse to the floor during general assembly. Do not insert these bolts if you intend to install your greenhouse on to soft ground.
11. In both cases, insert 1 bolt at each end of the base section to enable the corner bracket/base leg to be fitted later.

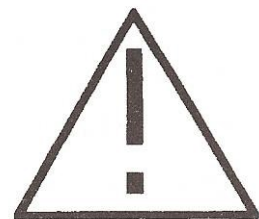
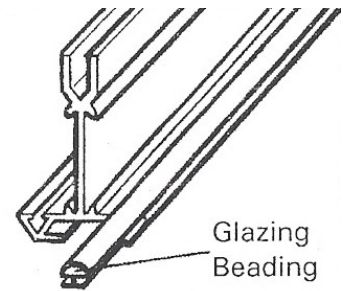

**BEWARE OF  
SHARP EDGES!**

Before assembling any sections slide the required number of bolts into the glazing bars. Lay out the component parts on the ground as though you were standing on the inside of a completed greenhouse, i.e. with the bolt slots uppermost.

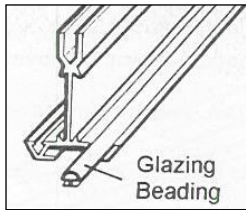

**GLAZING BAR**

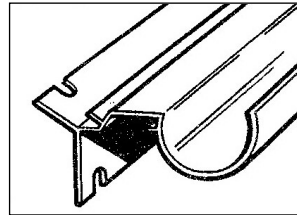

**EAVES BAR GUTTER**

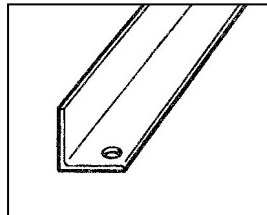

**ANGLED TIEBAR**

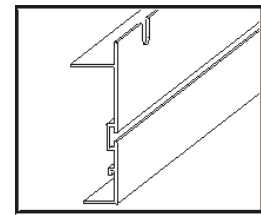

**BUILT-IN BASE**

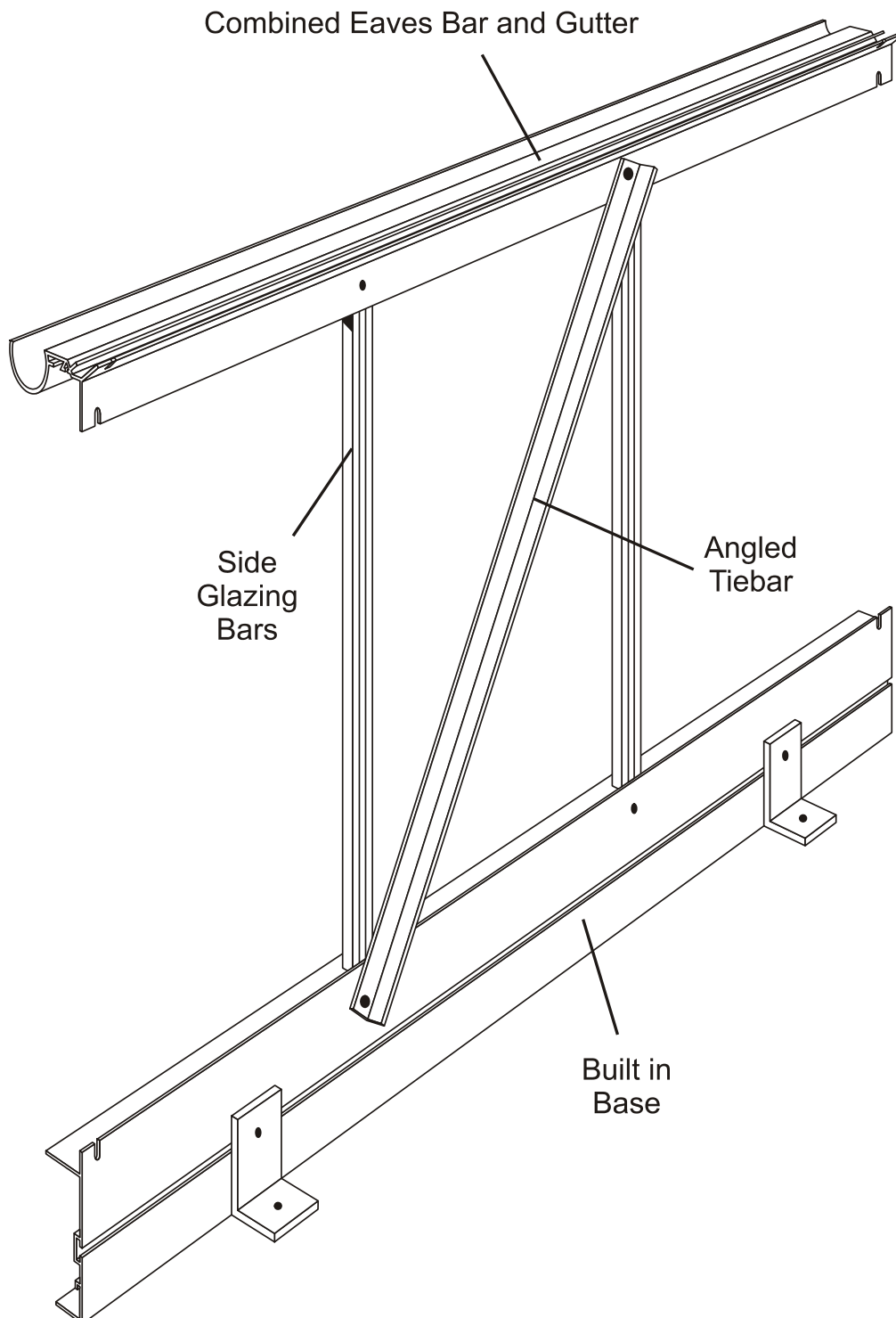



## REAR END ASSEMBLY

N.B. The roof corner bars are marked "R" on the outside, which indicate that they meet at the ridge and are also mitred at both ends. If you have a painted greenhouse there is no letter "R" on the corner bar. You **must** ensure that the "middle" hole is nearer to the ridge plate than the eave plate. (**Key point**).

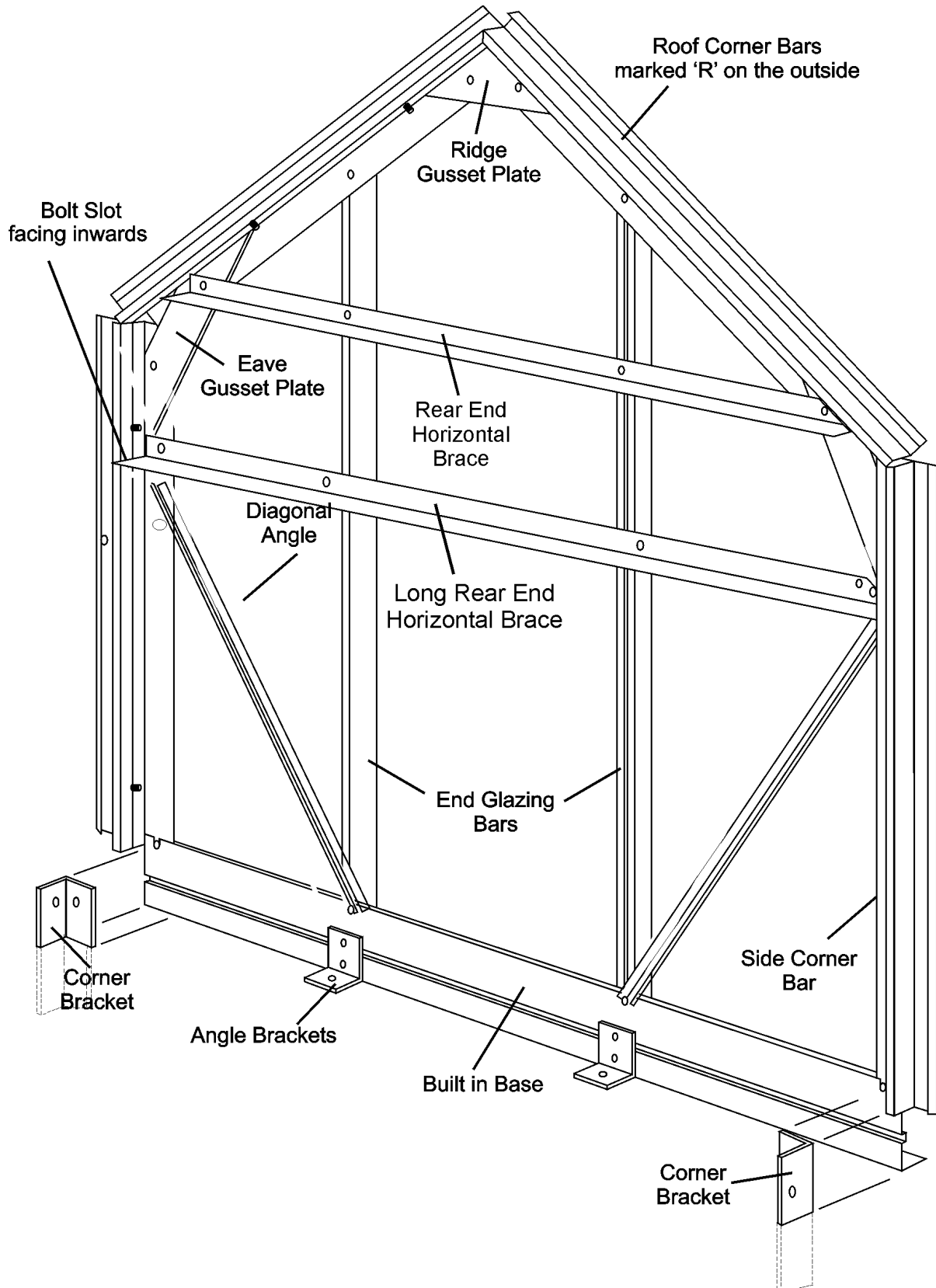

From the main bag of fittings you will require the nuts and bolts, two eave plates and one ridge plate. These are packed with the casement stay and are separate from the main bag of fittings.

Components:

- 1 Alloy built in base cill
- 2 Glazing bars
- 2 Diagonal bracing angles
- 2 Horizontal bracing angles (1 longer than the other)
- 2 Roof corner bars (marked "R" at the apex)
- 2 Side corner bars (unmarked)
- 2 Corner brackets/angle base legs

Corner bars are in two packs of 4 and are identical for both gables. They are marked "corner bars".

## INSTRUCTIONS

1. Lay out the frame as though you were standing on the inside i.e. with the bolt slot uppermost, roof corners marked "R" at the apex, opposite each other, facing downwards (i.e. "R" on outside). The roof corner bars are mitred at both ends where as side corner bars are mitred at one end only. **(Key point)**. The bolt slot is on the inside and faces inwards during initial construction. If you have a painted greenhouse there is no letter "R" on the corner bar. You **must** ensure that the "middle" hole is nearer to the ridge plate than the eave plates. **(Key point)**.
2. Slide the glazing beading into each glazing bar and corner bar taking care not to stretch the material. Trim off any surplus level with the ends of the glazing bar. The corner bars have 3 grooves to receive beading. **Do not** use the middle one, only the two outer grooves require beading.
3. Slide two bolts into the bolt channel of each corner bar (1 each end), put a nut on and finger tip tighten approx. 3" from the end of the bar. These will later be used in the general assembly for fixing the ridge, eave and cill to the ends. Now secure the ridge gusset plate and eaves gusset plates by inserting bolts through the 'plates' and into the holes punched in the flange of the corner bar, at the apex and eave. Do not tighten the nuts and bolts in the gusset plate at this stage, finger tip tighten is sufficient.
4. Attach the built in base cill to the side corner bars by inserting a bolt through the hole in the flange of the corner bar and into the slot in the cill.
5. Attach the vertical glazing bars to the built in base by inserting a bolt into the bolt channel of the glazing bars and locating it with the punched holes in the cill. Before securing the nuts attach the diagonal angle ties to the same bolt as illustrated. There are 3 holes close together near the top of the corner bar. The top of the diagonal angle tie now attaches to **middle hole** that is pre-fabricated at the top of the side corner bar. **(Key point)**.
6. Slide three bolts into the bolt channel at the top of the two vertical glazing bars and secure the last one to the roof corner bars by inserting the bolt through the punched hole in the flange.

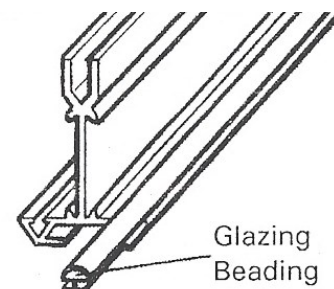

7. You can now attach the horizontal angle braces. The top horizontal is the shorter of the two braces and must attach to the **top bolt hole** of the eaves gusset plate and to the other bolts in the glazing bars you inserted in 6, page 10.
8. Now attach the longer horizontal brace to the top pre fabricated bolt hole near the top of the side corner bar, and the bolts inserted in the 2 end glazing bars.
9. Check that all angles between built in base cill and the vertical members are at right angles and that the glazing bars are right into the angle cill at the bottom. **(Key point).**
10. Tighten all nuts.
11. Slide a bolt into the bolt slot in the built in base section, one at each end. Attach the corner bracket (angle approx. 400mm long with 6 holes in, 2 at the top and 4 at the bottom) so that it is pointing downwards. If you are fitting your greenhouse onto soft ground, then do not fit the corner bracket yet. If you are on a patio, you will need to cut the corner bracket/angle base leg off level with the bottom of the built in base and slide extra bolts into the bolt channel to be attached to the anchor bracket (generally 1 every 2'). If you are on soil, the corner bracket will go into the ground at general assembly.

## DOOR END ASSEMBLY

From the main bag of fittings you will require the nuts and bolts, 2 eave plates and 1 ridge plate. These are packed with the casement stay and are separate from the main bag of fittings.

### Components

- 2 door end built in base
- 1 end glazing bars
- 2 side corner bars (unmarked)
- 1 top door track
- 4 short horizontal braces (2 longer than the other)
- 2 diagonal bracing angles
- 1 main door track support
- 2 roof corner bars (marked "R")
- 2 door end plates (rectangular plate with 3 slots)

## INSTRUCTIONS

1. Assemble the frame in exactly the same way as the rear end, up to and including stage 3 of the rear end. The difference with the door end is that instead of 1 long base piece, the door end has 2 smaller pieces (1 either side of the door opening) and 1 door end cill.
2. Now engage the door end cill with the 2 built in base cills by pushing the angle of the cill under the locator as shown in the diagram. At this stage the cill will move freely left and right but will remain located to the built in base cill.

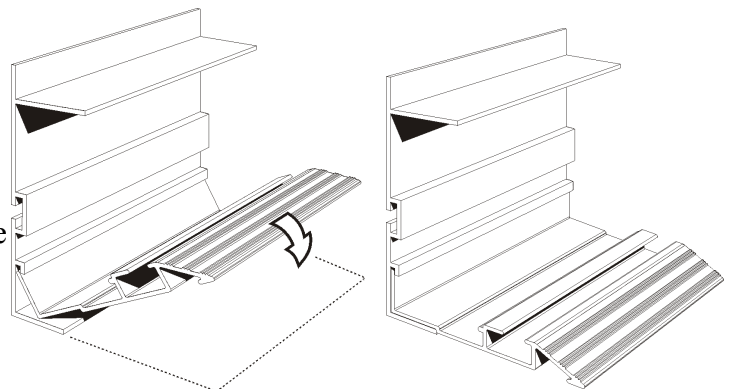
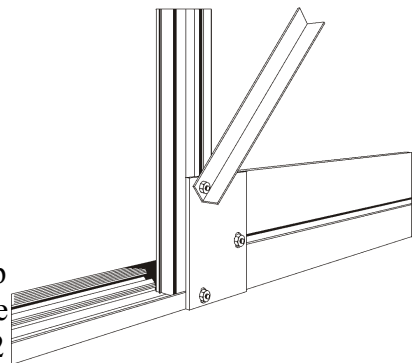

3. Slide 2 bolts into the bottom of each glazing bar and 3 bolts (only 1 if greenhouse to be sited on soft ground) into the free end of each built in base section. Attach the 2<sup>nd</sup> bolt in the glazing bar to the hole in the door end cill, but do not put a nut on yet.
4. Attach the rectangular door end plate (with 3 holes) to the 2 bolts inserted in the glazing bars and the last bolt inserted into the base ensuring that the glazing bar is tight down into the angle of the door end cill. Attach the diagonal angle to the top bolt of the rectangular door end plate and the other end of the diagonal brace to the middle hole at the top of the corner bar. The 2 unoccupied bolts in the base sections will be used to anchor the greenhouse to the floor.
5. Attach the main door track support (shaped like a letter 'Z' to be found with the door panels) to two bolts approximately 4" down from the point where the corner bar meets the two tall glazing bars. This 'Z' shaped bar must be fitted with the two outside slots facing upwards (as illustrated) **not** downwards. (**Key point**).
6. The two smaller horizontal braces attach to the **top bolt** in the gusset plate and the vertical glazing bars.
7. Now attach the 2 longer horizontal braces to the top bolt hole which are pre fabricated near the top of the side corner bar.
8. Stand the frame up and bolt the door track to the main door track support by inserting 3 bolts into the bolt slot of the door track. Position these through the 3 holes in the door track support above the door opening. Slide the door track until it is centrally positioned on the door end.
9. When this has been achieved tighten all nuts.
10. Using the bolt closest to the corner bar in the built in base, attach the corner bracket/angle base legs so that it is pointing downwards. If you are fitting your greenhouse onto soft ground, then do not fit the corner bracket yet. If you are on a patio, you will need to cut the bracket off level with the bottom of the built in base. If you are on soil, the bracket/angle base legs will go into the ground at general assembly.

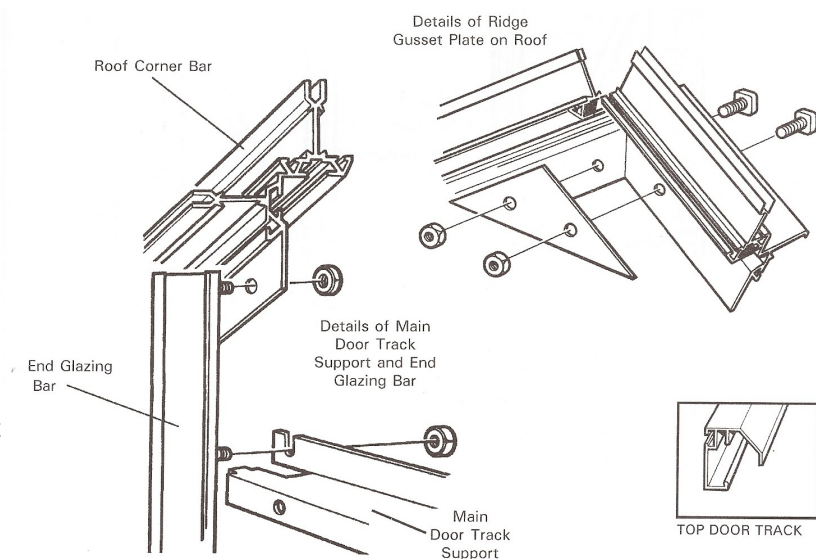

N.B. Please note carefully the correct position of the main door support. The slotted holes at either end are facing skywards NOT downwards. (**Key point**).

Please note, you only require approx. 150mm of beading in the inside 'v' groove of the end glazing bars.

# DOOR END ASSEMBLY

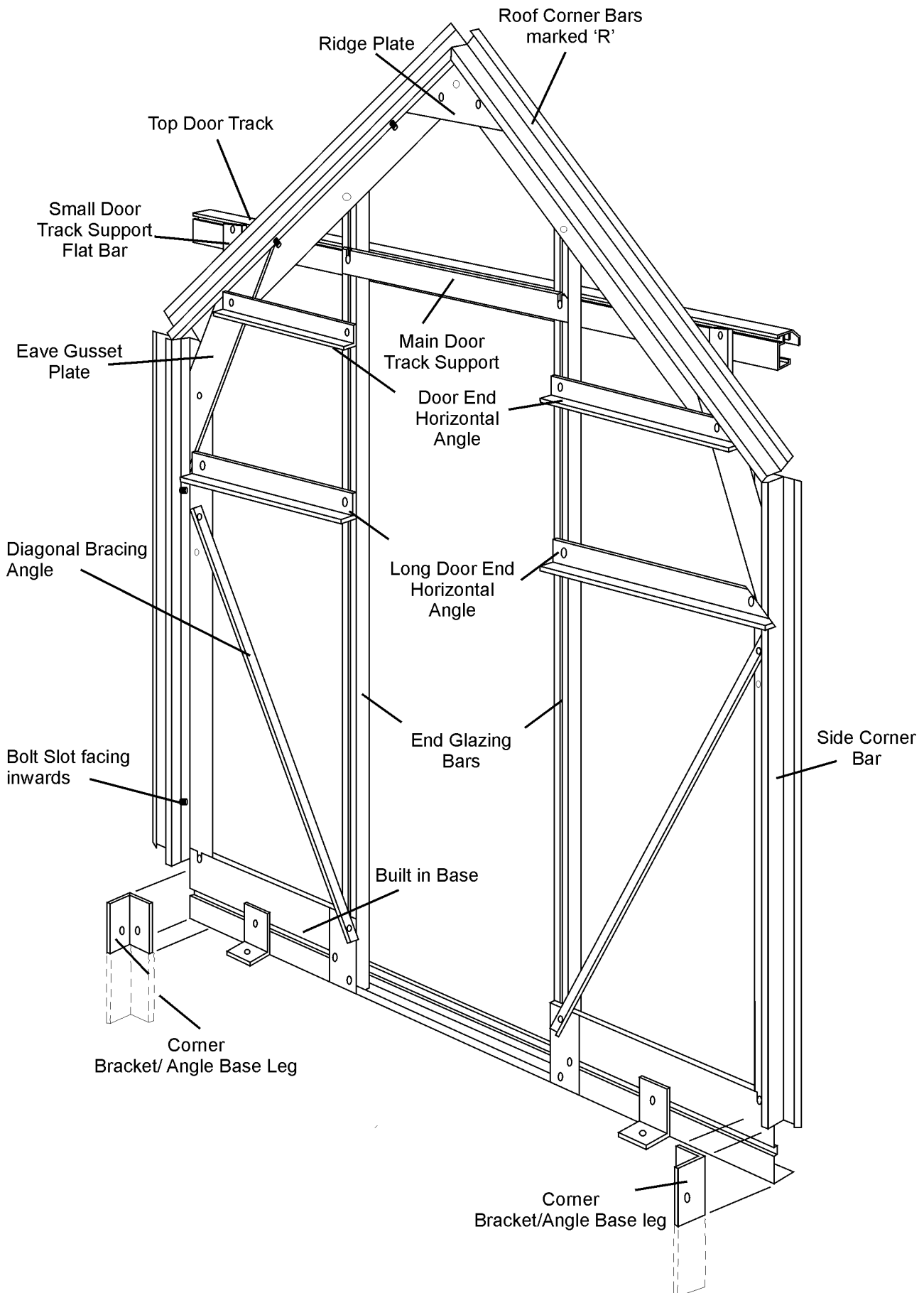

## DOOR FRAME ASSEMBLY

Each Door consists of:

1 unhandled door post

1 handed door post (handed post for left door is different profile to the handed right hand door post)

3 infill panels (1 with pre fabricated lock hole– right hand door only) for lock barrel

1 top and bottom door panels

3 panels of glass which must be fitted during door assembly. **It is not possible to fit glass after the door is built.**

From the main bag of fittings you require;

2 door wheels

1 clip on nylon door skid (this might already be fitted to the bottom door panel)

2 lengths of black brush draught excluder with P.V.C. carrier

Door lock, self tapping screws and spring washers

12' glazing beading

Door handles

3 P.V.C. glass strips

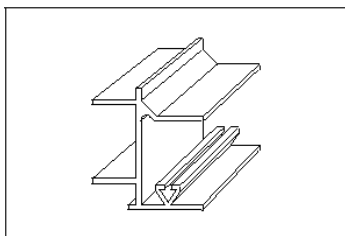

HANDED DOOR POST  
RIGHT HAND DOOR

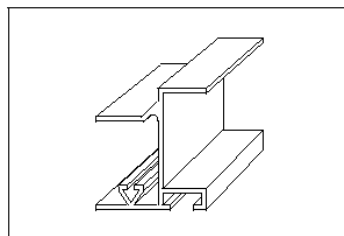

HANDED DOOR POST  
LEFT HAND DOOR

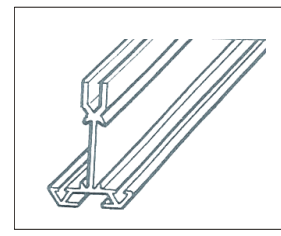

UNHANDLED  
DOOR POST

**Left hand Door (viewed from outside).**

**Identify the correct door posts.** The handed door post for the left hand door has a bolt channel, whereas the handed door post for the right hand door post does not. **(Key point).**

1. Place one unhandled post and the handed post for left hand door on a level surface roughly two feet apart with the bolt slots facing downwards. (Unhandled door post on the left, handed door post on the right). The top of each side post has two screw holes in it, the bottom has three. **(Key point).** Slide the glazing beading into the groove of each bar i.e. only one length of glazing beading per bar.

2. Place the top, bottom and 3 infill panels in position as shown by the position of the screw holes in the side pieces and the panels. The top panel has the greenhouse name on it. The bottom panel has the edge for the door skid to fit on. The lower infill panel locks on to the bottom panel. The infill panel for the left hand door **does not** have a pre fabricated hole for the lock barrel.

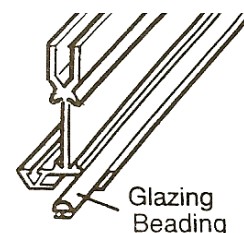

3. Fix the left hand door post to the door panels by screwing through the door side pieces into the holes provided in the edge of the panels with the self tapping screws. The screws will go in more easily and with out danger of trying to go crooked if you can put a small amount of grease on the screw before assembling the doors. Alternatively, you could insert the screws into the screw eyes of the door panels before assembling the door; this would have the effect of pre-self tapping the panels prior to assembly, making assembly easier.
4. **GLASS MUST BE FITTED TO EACH DOOR BEFORE THE 2ND DOOR POST IS FITTED. (KEY POINT).**

- Before fitting the unhandled door post, offer the glass panels to the door (see glazing plan in booklet for glass size guide on door), slide them in from the side. Carefully attach the unhandled door post in the same way as before, ensuring the glass is sitting in the correct position (sitting on the beading channels of the door posts) before tightening the screws.

- Make sure all angles are square and tighten all screws. Now insert 2 glazing clips to the glass on the unhandled door post. The handed door posts are clipped using the 6 pieces of clip capping (no metal clips) found in the greenhouse box (3 per door). The clip capping should be cut to the length of the glass, and pushed into the cavity between the frame of the door and the glass, so as to wedge the glass to the back frame of the door. See diagram for final resting position of the clip capping.

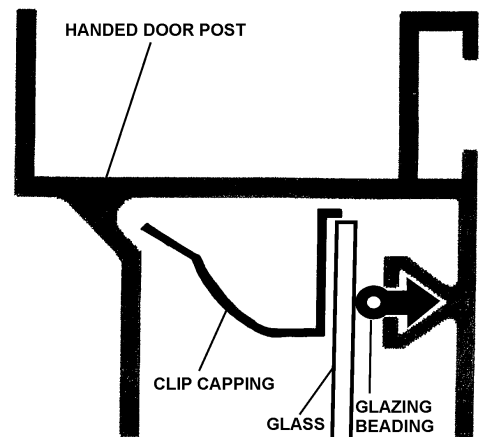

- Fix each door wheel into position by pushing the bolt provided through the centre of the wheel and then through the hole in the top door panel from underneath (i.e. from the inside of the door). Put the washer over the bolt and secure with the nut provided, tightening until there is no movement on the bolt. The nuts are lock-nuts and are harder to put on than normal nuts in general assembly. The wheel will revolve freely because it has ball bearings in it. **The wheel has a collar protruding from the centre, this collar goes against the inside face of the top door panel. (See picture).**

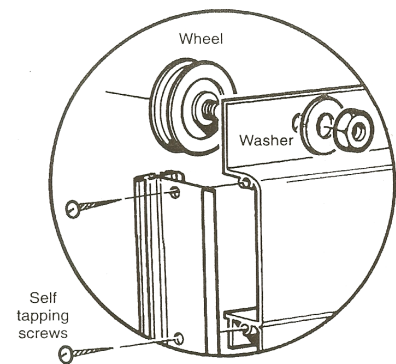

- Slip the nylon door skids on each of the bottom panels. This may already have been done prior to delivery. After fitting the doors (see later in the booklet), you may need to lower the door skid so that it engages with the bottom door cill to allow smooth movement of the door. Lower the skid on each door and insert a self tapping screw at each end of the skid to reinforce the position.

- Build the right hand door using the remaining handed and unhandled door post. Viewed from the outside, the handed door post will be on the left of the door, while the unhandled door post will be on the right. At this point you must decide the height you would like your door lock. The hole to take the door lock is on the left hand side of the infill panel. You can decide to fit this panel to the 2nd or 3rd panel down. **Make sure you fit the glass before final fixing of the door.** See glazing plan towards the back of this booklet.

- Thread the stainless steel backed brush extruder into the PVC carrier. This may already have been done prior to delivery.

- Turn the doors over and insert the black brush draught excluder in the groove (bolt slot) in the unhandled door posts. Insert a nut and bolt at the bottom of each unhandled door post and tighten so that the brush will not slip down when the door is in its upright position. Cut off the surplus brush and carrier at the top of the bar.

- Do not fit the door to the gable at this stage – wait until the structure is fully assembled prior to glazing.

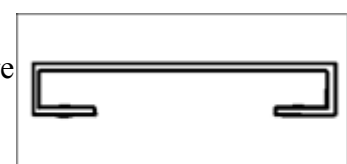

DOOR HANDLE



13. The handles are fitted to the infill panel on each door (choose between 1st or 2nd panel down). Position the handle centrally, and mark the hole position. Drill 7mm diameter holes (2 holes per door), then fit the handles, and secure with a nut and bolt.

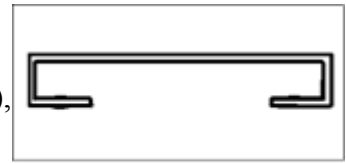

DOOR HANDLE



DRAUGHT EXCLUDER

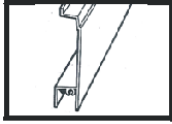

DOOR INFIL PANEL

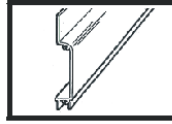

DOOR TOP/  
BOTTOM PANEL

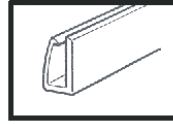

DOOR SKID

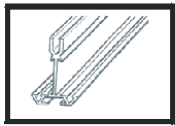

UNHANDLED  
DOOR POST

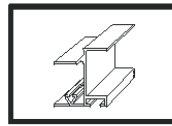

HANDED DOOR POST  
LEFT HAND DOOR

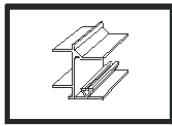

HANDED DOOR POST  
RIGHT HAND DOOR

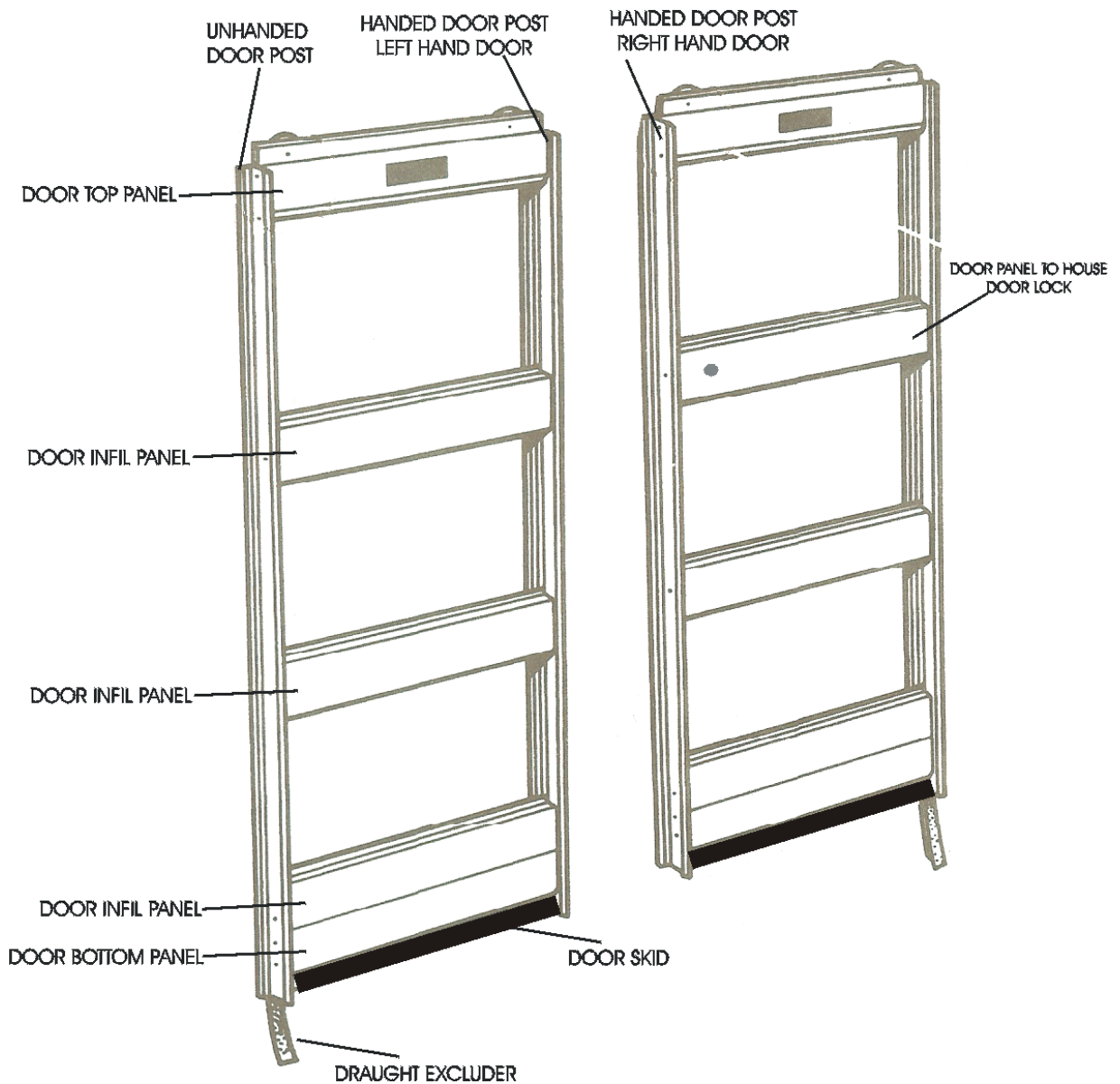



# ROOF VENT ASSEMBLY

The roof vent pack has 5 pieces of aluminium and from the main box of fittings you require:

Glazing beading

4 nuts and bolts

2 casement stay pins

1 casement stay

6 M4 stainless steel nuts and bolts.

## PROCEDURE:

1. Identify the slam bar and attach the 2 stay pins to the outer side of the angle using the M4 stainless steel nuts and bolts.
2. Lay the 4 edge pieces of the vent on a level surface as though you were on the inside of the vent (with the bolt slots of the side bars uppermost and the 'v' slots of the bottom rail uppermost). The top rail is arranged in such a way that the squared off end is to the bottom and the hooked hinge uppermost).
3. Slide the glazing beading into the slot in the side and top rails and trim to suit.
4. Insert a bolt into each end of the side rail bolt slots, put these bolts through the holes in the top and bottom rails, add nuts and lightly tighten. Check that all joints are secure and that the vent is square, then tighten up the nuts.
5. Fit the casement stay using the M4 stainless steel nuts and bolts, putting the bolts through the holes in the saddle of the stay through the 2 elongated holes in the bottom rail. Hold the nuts in place and tighten the bolts with a screwdriver.

Do the same with the other vents.

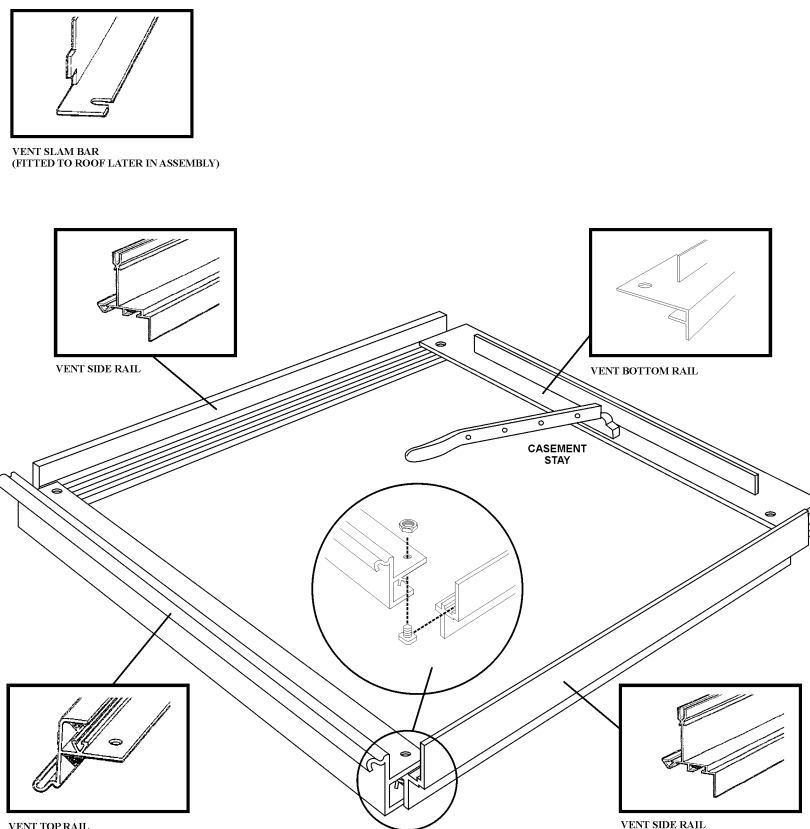

# ASSEMBLY OF GREENHOUSE UNIT

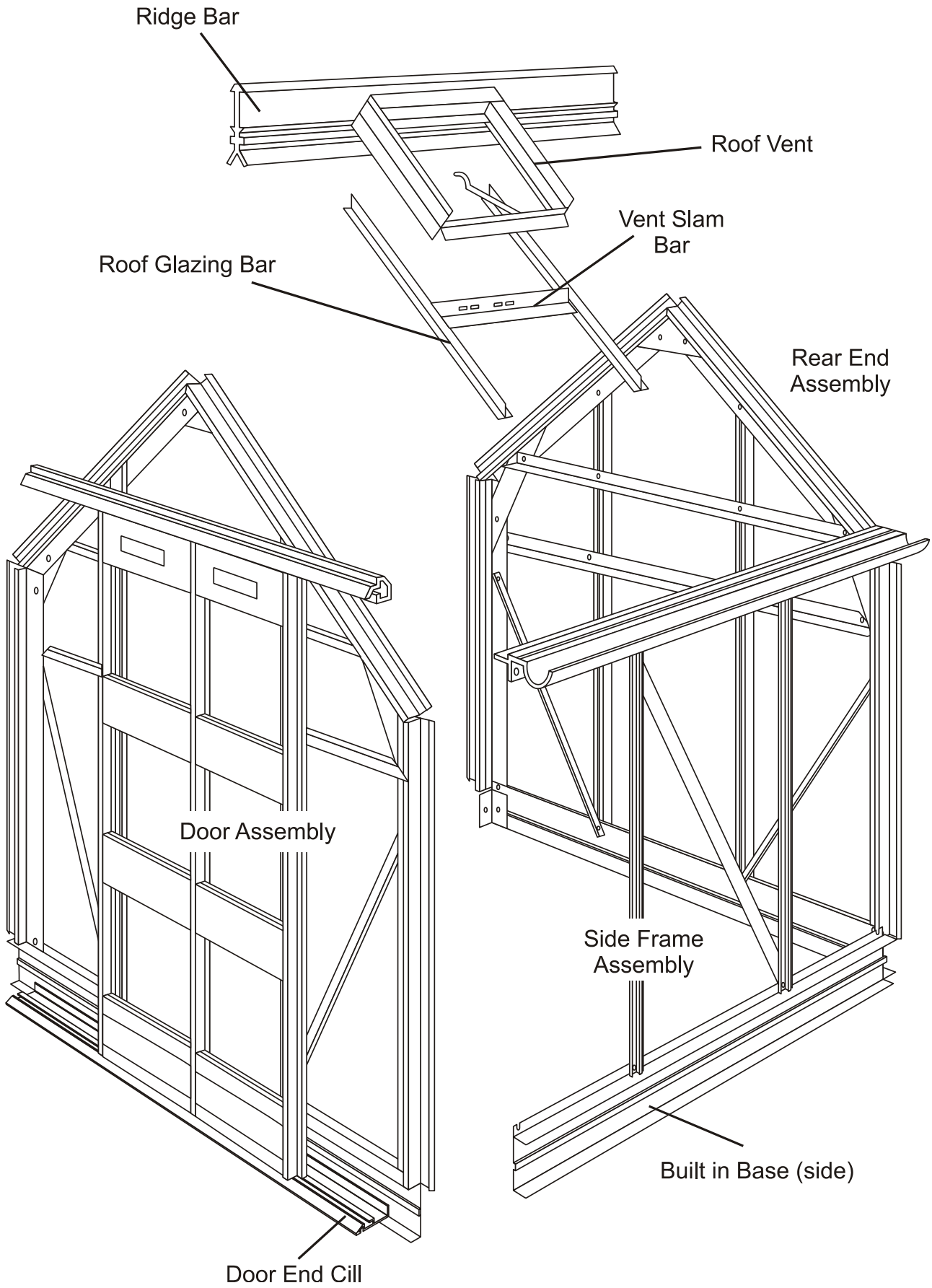

## ASSEMBLY OF GREENHOUSE UNIT

The first operation is to connect the two side frames to the end frames to form the outer shape of the completed structure. Another pair of willing hands would be useful at this stage.

1. Lift the first side frame into its position by the rear end.
2. Slot the eaves bar into the small space between the roof and side corner bar so that the gutter is outside the end frame and the two flanges that form the angle of the roof and side are inside and tight up against the bolt slots of the roof and side corner bar. **(Key point)**.
3. The extra bolts that were inserted in the bolt slots during the gable end assembly can now be used.
4. Line up the elongated holes in the flanges of the eaves with the bolt slots and slide the bolts into them. Put a nut on the top bolt and tighten up. **(Key point)**.
5. The built in base attaches to the inside of the corner bar. The bolt placed in the corner bar bolt slot at gable end assembly will slide down into the slotted hole at the end of the built in base cill. Likewise with the angle base leg, this can now be attached to the end built in base cill utilising the bolts inserted at frame assembly.
6. Do the same at the other three corners.

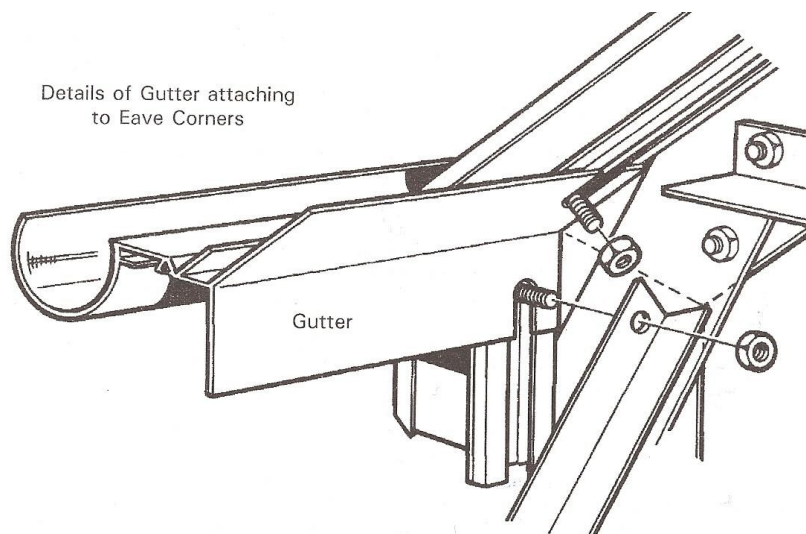

7. Slide the glazing beading into both sides of the ridge before attaching the ridge to the roof corner bars. Insert the end of the ridge through the small gap in the corner bars at the top, the vertical part of the ridge will be outside, pointing skywards and the two flanges that form the angle of the roof will be inside, tight up against the bolt slots of the roof corner bars.
8. Line up the slotted holes at the end of the ridge with the bolt slots in the corner bars. Push the two bolts, previously inserted during the gable end assembly into the slots. Put on nut and tighten.

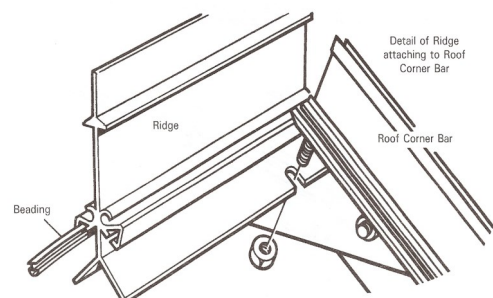

9. The roof bars can now be attached to the ridge and gutter. **Slide the glazing beading into the grooves on each bar.** Attach them to the ridge first by sliding a bolt into the bolt slot of the glazing bar and inserting it through the hole in the flange of the ridge. Put a nut on and tighten up. Do the same with the rest of the roof bars.

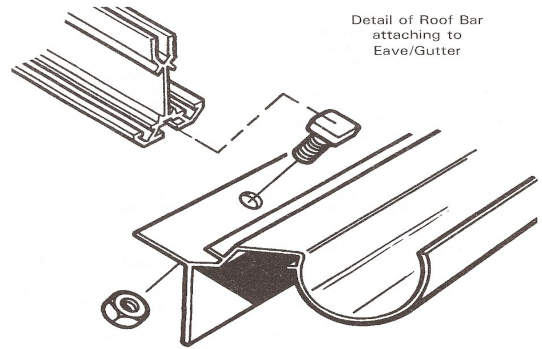

10. Before bolting the bottom of the roof bar to the flange of the eave bar, insert 1 extra bolt per bar to attach the cantilever brace. Where the vent is to be positioned put an extra one bolt per bar i.e. the vent covers two glazing bars so two extra bolts per vent. **(Key point).** Then attach the final nut and bolt to the eave bar as illustrated.

11. Now attach the cantilever brace as shown in the picture using the bolts inserted above and in side frame assembly.

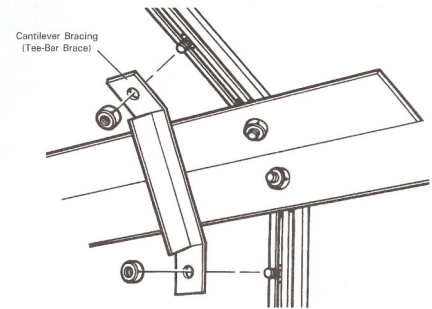

## NOW YOU CAN FIT THE VENT TO THE RIDGE

12. Slide the vent onto the ridge from either end and into the desired position. Before sliding the vent into the ridge, slide a piece of black tube into the vent hinge socket. Slide the vent into position, insert a small self tapping screw into the tube approximately  $\frac{1}{2}$  way along then tighten the screw. The tube will expand and lock into position thus preventing sideways movement of the vent.

N.B. There is no hole for the screw but it will easily push into the tube and screw up. **(Key point).** You only require one tube per vent on the left hand side of the vent socket (viewed from inside the greenhouse).

The vent overlaps the two glazing bars that it covers so is therefore wider than the opening.

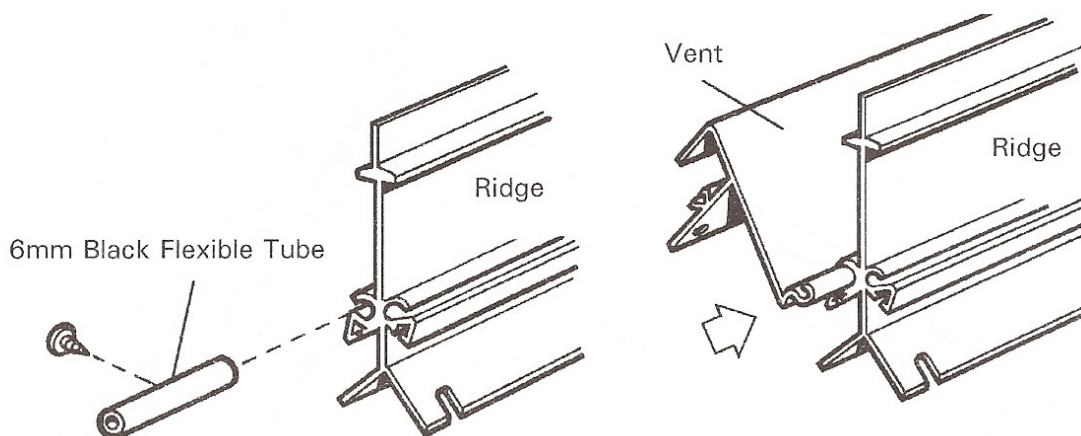

Having slid the vents from the end on the ridge to the desired position, you can now fit the “slam bars” to the 2 glazing bars. Utilise the bolts you inserted during general assembly and position the “slam bars” just under the vent allowing the casement stay to effectively close. The slam bar can be adjusted later to facilitate good opening and closing of the vent.

NB. If one of your vents is going next to an end corner bar the tube will only function if the vent is either in bay No1 on the right hand side or last bay on left hand side. (Viewed when walking through the door.) If the vent is fitted in one of the end bays in the roof, you must drill the roof corner bar and fix an angle bracket to prevent the vent from moving out of position.

13. Do not fit the doors at this stage.
14. The greenhouse is now ready for lifting on to its permanent base.
15. If you are fitting the greenhouse onto soft ground, you now need to dig 1 hole (approx. 1 spade width) in each of the 4 corners.
16. Lift the greenhouse into position. For soft ground fixing, you now need to attach the corner bracket/angle base legs to the bolt slot of the side and end using the end of the bracket that has 2 holes as oppose to 4. The bracket/angle base legs must be attached in such a way that the end with 4 holes is pointing down into the hole previously made. You will need a flagstone sunk to ground level underneath the door opening in order to attach the bottom cill and threshold so they are permanently anchored to stop any movement. **(Key point).**

## **SQUARING UP**

You must make sure that the structure is level and square. Put one pane of glass in each corner of roof, each pane must be level with the small glass retaining lip just above the gutter and be running parallel with the roof glazing bars. Each corner must be the same. If one corner is out the corner diagonally opposite will also be out. By carefully pushing and pulling each corner diagonally you will be able to see the frame move in and out of square with the glass.

## **HARD STANDING**

Having established the square of the greenhouse, drill the patio or concrete in the required positions, fit plastic plugs and screw the brackets (attached during subassembly) firmly to the ground using 35mm x 8mm round head screws.

## **SOIL FLOOR**

Determine the square of the greenhouse as described above, make a mix of concrete and put a couple of shovelfuls around the base of each stake. When the concrete has gone off back fill with the soil excavated earlier on. Do not concrete the corners until you are certain the structure is LEVEL & SQUARE.

## FITTING THE DOORS TO THE STRUCTURE

The doors slide onto the frame from opposite sides of the door tracks. For the left hand door put the door bottom rail into the bottom door track and slide to the right, feed the first wheel into the top door track and move further to the right until the black draught excluder butts up to the end glazing bars. Repeat the process for the right hand door. (Ensure handed door posts meet in the middle). It may help in the fitting of the doors to remove the angle on the back of one of the doors and refit it once the doors are on.

The doors will now run quite freely. To square up the door with the spacing, undo the upper bolts holding the door track. There is a little play to facilitate “fine tuning” of the doors. N.B. Sometimes the doors can be a little stiff prior to glazing but once the glass has been inserted (the last job of the construction) the extra weight will make for smooth running. **(Key point).**

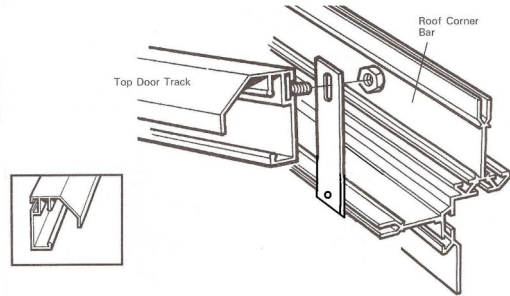

Loosely attach 2 flat bars to the bolt channel of the door track (1 each end) and allow to hang vertically downwards. The flat bar has 2 holes. Attach the larger hole to the door track by inserting a bolt into the channel of the track. Now slide the flat bar along the door track until the point that the smaller hole of the flat bar meets the self tapping screw groove of the roof corner bar. If you are happy that the doors are running smoothly, insert a self tapping screw into the smaller hole of the flat bar and in turn into the self tapping groove and tighten. Repeat on the other end of the door track. This attachment will support the weight of the doors when they are in the open position.

## FITTING THE DOOR LOCK

The door lock must be fitted after the doors are in position. **(Key Point).** Undo the ring bolt from the door lock, and insert the barrel through the hole in the panel from the outside. Re-attach the ring bolt to the barrel on the inside, and tighten.

Now attach the cam lever, washer and screw to the door lock from the inside position of the door. The lock will turn through 90 degrees both ways, so you must ensure the cam (when fitted) is pointing skywards (unlock position) and horizontal (locked position).

Now using a cropped head bolt, attach the domed pin to the bolt channel of the handed door post on the left hand door (viewed from outside). Move the pin up or down in the channel so that the notch on the cam locates comfortably when horizontal. Tighten all components.

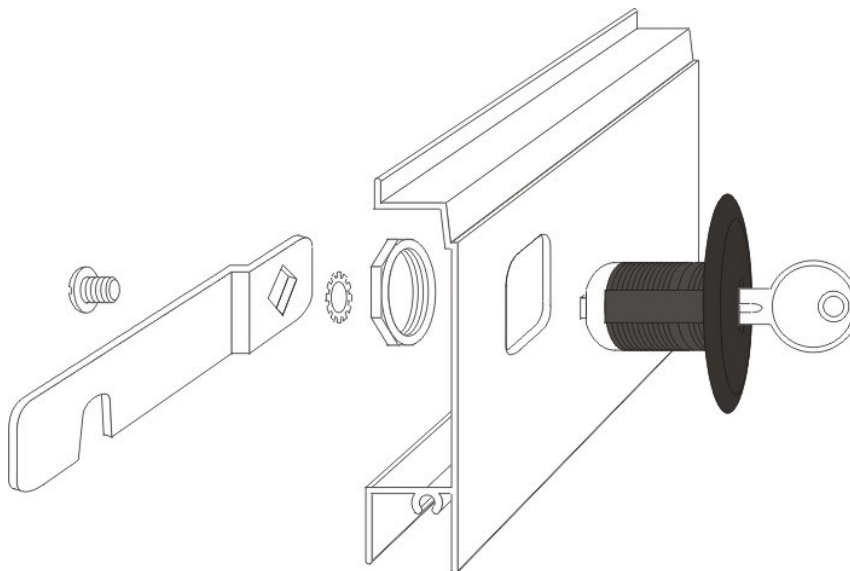



## FINISHING OFF

To prevent the door from sliding past its opening, you must fix 2 angle brackets to the door end assembly. Insert a cropped head bolt into the bolt channel at the top of the left hand glazing bar (viewed from the inside) and fix an angle bracket as shown in the picture.

The bracket must be fitted at the same height as the door panel so that, as the door moves left or right, the bracket prevents the door from moving too far along the top door track.

Repeat at the bottom of the door.

Repeat for the 2nd door.

To facilitate smooth running of the door, fit 1 flat bar at each end of the top door track.

The flat bar has 2 holes of different size.

Loosely fix the larger hole to the bolt channel at the back of the top door track using a short bolt and allow the flat bar to hang vertically down.

Move the flat bar along the top door track until the small hole in the flat bar meets the self tapping screw groove in the roof corner bar.

Fix the small hole in the flat bar to the corner bar using a self tapping screw.



## FITTING THE RAMP

The final aluminium piece of the greenhouse is the door end ramp cill. The ramp is attached to the door end cill by engaging the nub of the door end cill to the 'C' groove of the ramp. The ramp is now rotated to horizontal. Drill a hole at each end approx. 20mm in from the end of the ramp and into the floor. Plug and screw.

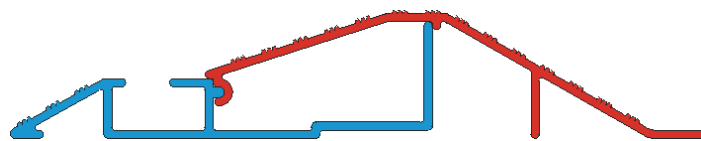

If you are fitting onto soft ground, you must ensure that a solid material is underneath the ramp to avoid damage when you step on the ramp to enter the greenhouse. You can lay a row of bricks sunk to ground level, a concrete flag, a piece of aluminium base pressed into the ground to ground level or something similar. You can then screw the ramp into the support material for a secure fixing. (See 'fitting the ramp' above).

## GLAZING THE STRUCTURE

Always handle glass with extreme care as failure to do so can result in injury. If you intend to fit bar capping, please read the capping installation sheet before you start glazing the greenhouse. The capping installation sheet can be found inside the box containing bar capping along with the capping screws and wire clips. **(Key Point).**



### HORTICULTURAL GLASS and MULTI-SHEET TOUGHENED GLASS

- Starting with the bottom pane of one side, offer the pane to the glazing bars. Hold it in place by inserting two of the stainless steel band clips six inches from the bottom of the glass. Fit the curved lip under the glazing bar and then rotate it so that the other lip (the end that has a distinct 90 degree bend) clips over the edge of the glass. **(Key Point).**

- Secure the glass by inserting another two clips in the same way half an inch from the top edge of the glass. **N.B. The side panels will require a larger overlap of approx. 3/4" (20mm).**

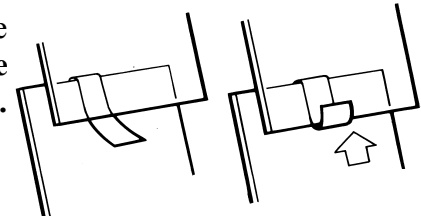

- Hook one overlap clip on the middle of the pane of glass. **(Key Point).**

- Offer the next pane of glass to the glazing bars, resting it on the two clips of the bottom pane. Insert two clips to hold it six inches from the bottom of the pane. Bend the middle overlap clip upwards to support the glass. Secure the pane by inserting another two clips four inches from

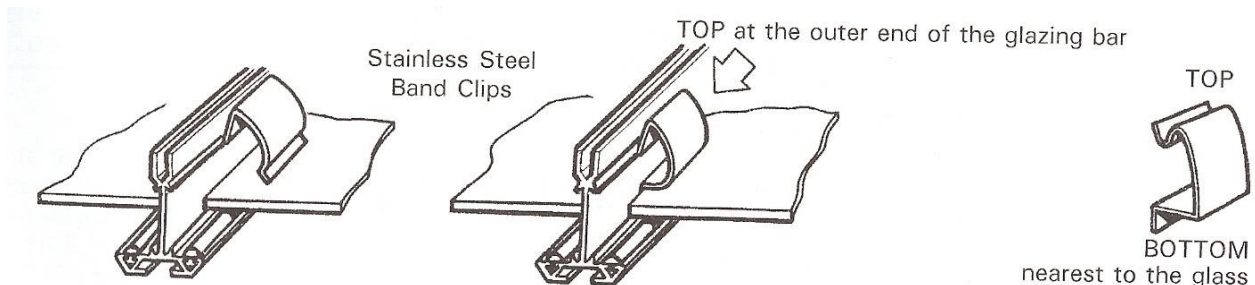

the top of the pane.

- Repeat this all along this side of the house, then repeat it for the roof of this side, but note that you have to use two of the stainless steel wire clips on the sides of the panes nearest to the roof vent so that the vent will close correctly. (See illustration for the correct way to fit these). **(Key Point).**

- Repeat the glazing procedure on the other side of the greenhouse.

- Following this, glaze the rear end in a similar fashion.

- Proceed to the door end and glaze, but use wire clips on the left hand edges of the panes to the left and right hand side of the door opening, so that the door slides open correctly. **(Key Point).**

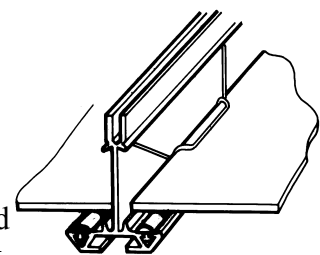

WIRE CLIP



# DELTA HORTICULTURAL GLASS/ & MULTI-SHEET TOUGHENED GLASS

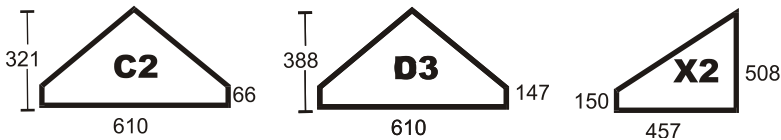
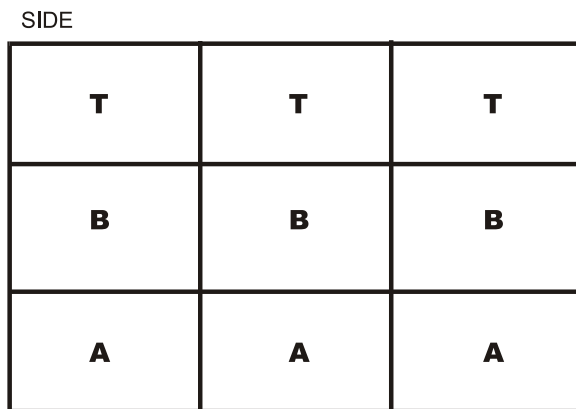
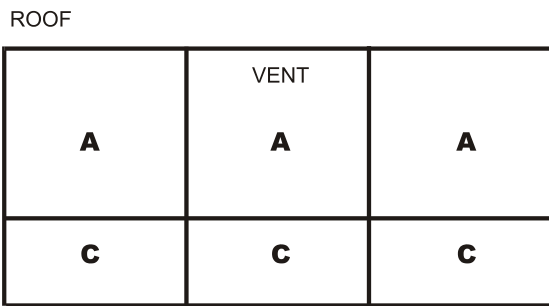
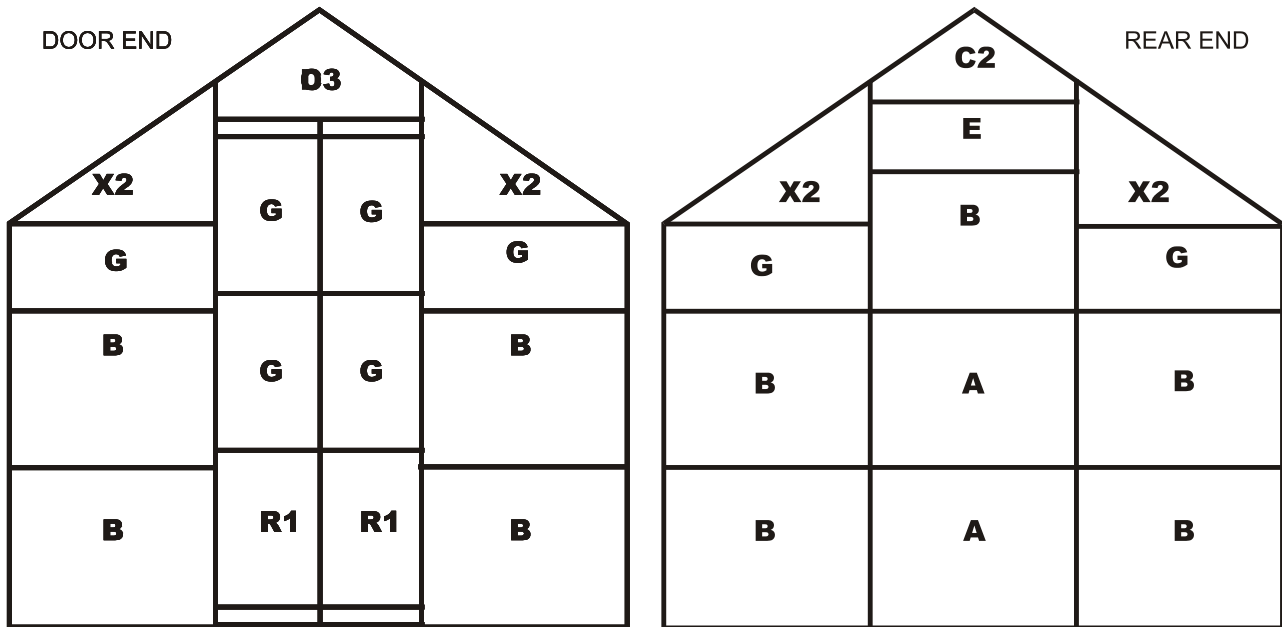

Ref Size	A	B	C	E	G	R1	T	C2	D3	X2
4 x 5	10	13	4	1	8	2	4	1	1	4
6 x 5	14	15	6	1	8	2	6	1	1	4
8 x 5	18	17	8	1	8	2	8	1	1	4

Ref	Width (mm)	Length (mm)
A	610	610
B	610	457
C	610	410
E	610	305
G	298	457
R1	298	610
T	610	590

Louvre: one 610 x 140 and the louvre replaces one @ A. The louvre must be sandwiched between 2 pieces of glass.

## FULL SHEET TOUGHENED GLASS (EN12150)

The main differences in application between the two types of glazing are:

1. Toughened glass is in large sheets.
2. There are no overlaps: where there are two or more panes in a section they are butt jointed with a P.V.C overlap strip – (called a muntin) – **you do not use muntins if you have multi-sheet (or small pane) toughened glass.** Muntins are found inside the glass pack containing the small shapes and rectangles.
3. See the diagram for the position of the different sizes.
4. The glass is clipped onto the frame in the same way as the horticultural glass is, but use 8 clips per large pane. Please refer to the pictures below on how to fit the clip.
5. Put the P.V.C overlap muntin on top of the lower pane making sure you have differentiated between the inside and outside of the P.V.C muntin (see diagram below). The next pane sits on top of the overlap and is clipped in as normal.
6. If you have ordered bar capping, it is important to cap each roof panel as you glaze. In addition you must use wire clips (found in your capping box) not the band clips. Applying capping after the roof is glazed would involve stretching over the glass which would be unsafe.
7. If you have ordered hybrid panels, for installation of hybrid panels, see A4 sheet attached to your delivery note.

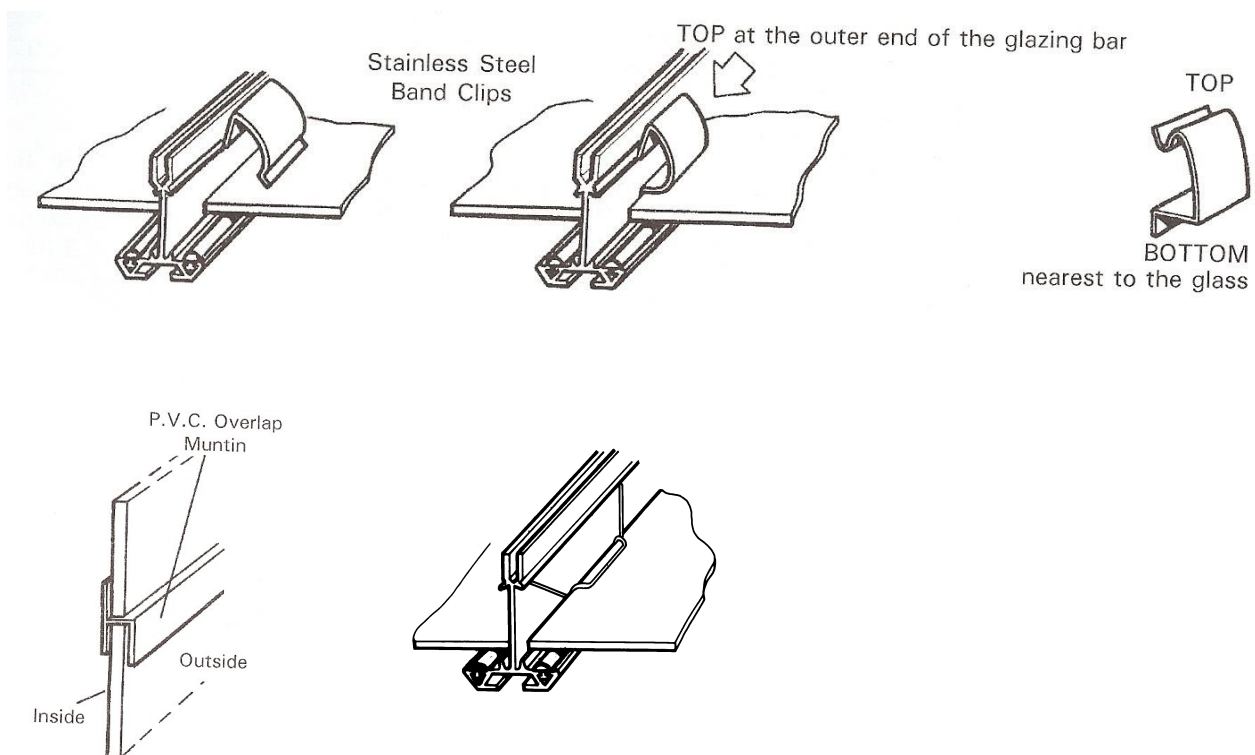

# DELTA TOUGHENED GLASS

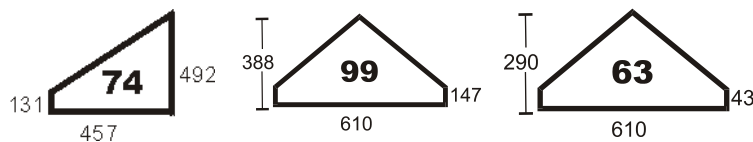
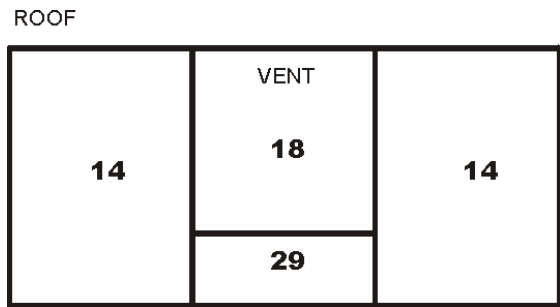
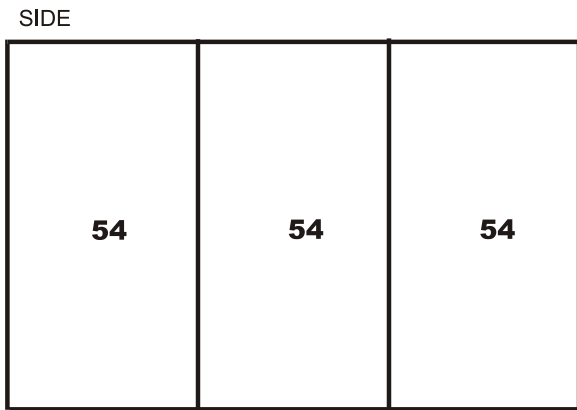
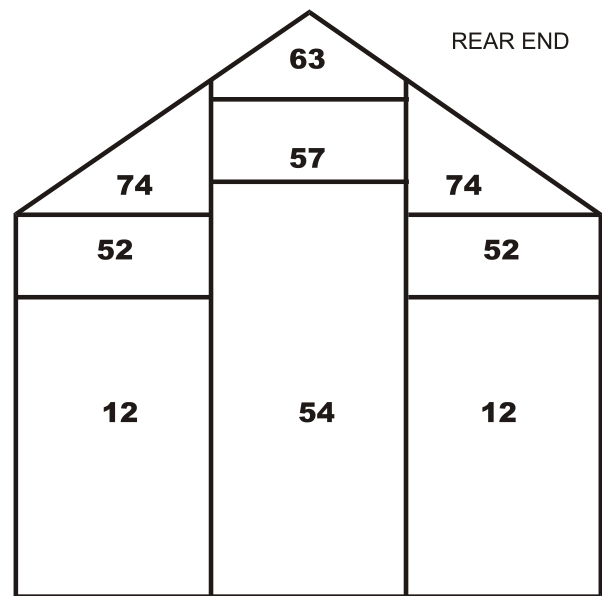
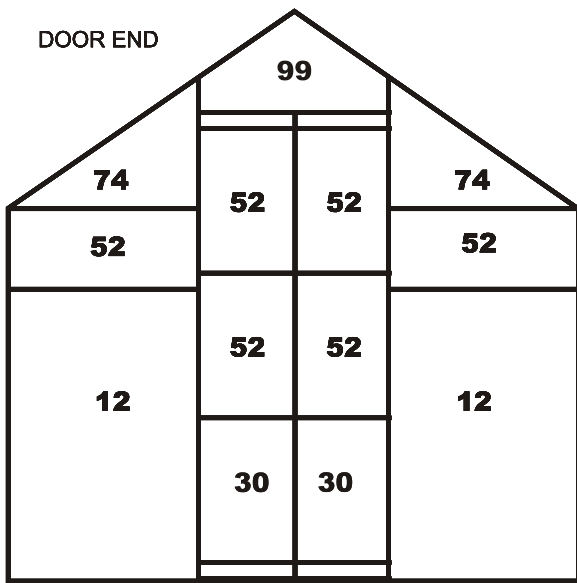

Ref	Width (mm)	Length (mm)
12	457	1197
14	610	1003
18	610	610
29	610	410
30	298	610
52	298	457
54	610	1630
57	610	318

The quantities above will change slightly if you have ordered extra vents and louvres.

N.B. If you have a louvre fitted in the rear or the side, replace one ref 54 with 610mm x 280mm, the louvre and 1 pane 610 x 904mm. The louvre must be sandwiched between the two panes of glass. It must not sit directly onto the aluminium base cill. If the louvre is obstructed by the side diagonal brace, then simply move the brace to another bay on the side assembly. The diagonal brace on the other side frame assembly should be in the same bay.

Ref Size	12	14	18	29	30	52	54	57	63	74	99
4 x 5	4	3	1	1	2	8	5	1	1	4	1
6 x 5	4	5	1	1	2	8	7	1	1	4	1
8 x 5	4	7	1	1	2	8	9	1	1	4	1

**YOUR GREENHOUSE IS NOW COMPLETE.**

**ELITE 1803**